

Panasonic
ideas for life

**2A and 3A space saving
PC board terminal type**

AQ8 RELAYS

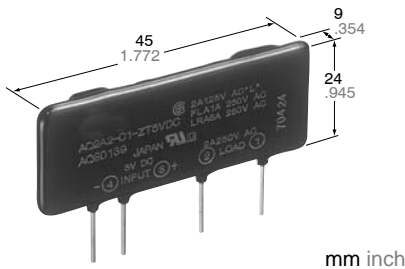

FEATURES

1. Slim with 9 mm .354 inch thickness
The thin type (45 mm long x 24 mm high x 9 mm wide) (1.772x.945x.354 inch) permits high density mounting.

2. Excellent in noise resistance
Since the input and output are insulated by the phototriac coupler, the noise on the output side is not fed back to the input side.

3. Snubber circuit integrated
The snubber circuit is integrated to prevent malfunction caused by the rapid rise of the voltage on the output side, such as inductive load and noise.

4. Zero-cross and Non zero-cross types are available.

The zero-cross type generates minimal noise by suppressing occurrence of radio frequency interference (RFI) and electro-magnetic interference (EMI).

The non zero-cross type features a short operation time which permits phase control.

5. High dielectric strength: 3,000 V AC (between input and output)

6. Two kinds of terminals distance are available. (5.08 mm and 7.62 mm) (.200 and .300 inch)

7. High reliability, long life and maintenance-free

TYPICAL APPLICATIONS

Most suitable as drivers for small size AC motors, solenoids, solenoid valves and so on.

1. Copying equipment
2. Air conditioners
3. Industrial equipment such as NC machines, sequencers, robots and so on

TYPES

1. Zero-cross type

Input terminals distance	Max. load current	Load voltage	Input voltage	Part No.
5.08 mm .200 inch type	2 A	75 to 125 V AC	5 V DC	AQ2A1-C1-ZT5VDC
			12 V DC	AQ2A1-C1-ZT12VDC
			24 V DC	AQ2A1-C1-ZT24VDC
		75 to 250 V AC	5 V DC	AQ2A2-C1-ZT5VDC
			12 V DC	AQ2A2-C1-ZT12VDC
			24 V DC	AQ2A2-C1-ZT24VDC
	3 A	75 to 125 V AC	5 V DC	AQ3A1-C1-ZT5VDC
			12 V DC	AQ3A1-C1-ZT12VDC
			24 V DC	AQ3A1-C1-ZT24VDC
		75 to 250 V AC	5 V DC	AQ3A2-C1-ZT5VDC
			12 V DC	AQ3A2-C1-ZT12VDC
			24 V DC	AQ3A2-C1-ZT24VDC
7.62 mm .300 inch type	2 A	75 to 125 V AC	5 V DC	AQ2A1-C2-ZT5VDC
			12 V DC	AQ2A1-C2-ZT12VDC
			24 V DC	AQ2A1-C2-ZT24VDC
		75 to 250 V AC	5 V DC	AQ2A2-C2-ZT5VDC
			12 V DC	AQ2A2-C2-ZT12VDC
			24 V DC	AQ2A2-C2-ZT24VDC
	3 A	75 to 125 V AC	5 V DC	AQ3A1-C2-ZT5VDC
			12 V DC	AQ3A1-C2-ZT12VDC
			24 V DC	AQ3A1-C2-ZT24VDC
		75 to 250 V AC	5 V DC	AQ3A2-C2-ZT5VDC
			12 V DC	AQ3A2-C2-ZT12VDC
			24 V DC	AQ3A2-C2-ZT24VDC

2. Non zero-cross type

Input terminals distance	Max. load current	Load voltage	Input voltage	Part No.
5.08 mm .200 inch type	2 A	75 to 125 V AC	5 V DC	AQ2A1-C1-T5VDC
			12 V DC	AQ2A1-C1-T12VDC
			24 V DC	AQ2A1-C1-T24VDC
		75 to 250 V AC	5 V DC	AQ2A2-C1-T5VDC
			12 V DC	AQ2A2-C1-T12VDC
			24 V DC	AQ2A2-C1-T24VDC
	3 A	75 to 125 V AC	5 V DC	AQ3A1-C1-T5VDC
			12 V DC	AQ3A1-C1-T12VDC
			24 V DC	AQ3A1-C1-T24VDC
		75 to 250 V AC	5 V DC	AQ3A2-C1-T5VDC
			12 V DC	AQ3A2-C1-T12VDC
			24 V DC	AQ3A2-C1-T24VDC
7.62 mm .300 inch type	2 A	75 to 125 V AC	5 V DC	AQ2A1-C2-T5VDC
			12 V DC	AQ2A1-C2-T12VDC
			24 V DC	AQ2A1-C2-T24VDC
		75 to 250 V AC	5 V DC	AQ2A2-C2-T5VDC
			12 V DC	AQ2A2-C2-T12VDC
			24 V DC	AQ2A2-C2-T24VDC
	3 A	75 to 125 V AC	5 V DC	AQ3A1-C2-T5VDC
			12 V DC	AQ3A1-C2-T12VDC
			24 V DC	AQ3A1-C2-T24VDC
		75 to 250 V AC	5 V DC	AQ3A2-C2-T5VDC
			12 V DC	AQ3A2-C2-T12VDC
			24 V DC	AQ3A2-C2-T24VDC

Remark: Standard packing Carton: 20 pcs.; Case: 200 pcs.

RATINGS

1. Rating (Ambient temperature: 20°C, 68°F; Voltage ripple on the input side: 1% or less)

1) Zero-cross type

• 2 A type

Item \ Part No.		AQ2A1-C1-ZT5VDC AQ2A1-C2-ZT5VDC	AQ2A1-C1-ZT12VDC AQ2A1-C2-ZT12VDC	AQ2A1-C1-ZT24VDC AQ2A1-C2-ZT24VDC	AQ2A2-C1-ZT5VDC AQ2A2-C2-ZT5VDC	AQ2A2-C1-ZT12VDC AQ2A2-C2-ZT12VDC	AQ2A2-C1-ZT24VDC AQ2A2-C2-ZT24VDC	Remarks
Input side	Control voltage	5 V DC (4 to 6V)	12 V DC (9.6 to 14.4V)	24 V DC (21.6 to 26.4V)	5 V DC (4 to 6V)	12 V DC (9.6 to 14.4V)	24 V DC (21.6 to 26.4V)	The parenthesized values represent the allowable voltage ranges
	Input impedance	Approx. 0.18 k Ω	Approx. 0.55 k Ω	Approx. 1.4 k Ω	Approx. 0.18 k Ω	Approx. 0.55 k Ω	Approx. 1.4 k Ω	
	Drop-out voltage	min. 0.5 V	min. 1.2 V	min. 2.4 V	min. 0.5 V	min. 1.2 V	min. 2.4 V	
Load side	Max. load current	2 A*1						At ambient temperature of 30°C or less
	Load voltage	75 to 125 V AC			75 to 250 V AC			
	Frequency	45 to 65 Hz						
	Repetitive peak OFF voltage	400 V			600 V			
	Non-repetitive surge current	30 A*2						In one cycle at 60 Hz
	Max. "OFF-state" leakage current	2.5 mA/100 V applied			5 mA/200 V applied			
	Max. "ON-state" voltage drop	1.6 V						at max. carrying current
	Min. load current	25 mA*3			50 mA*3			
OFF state dV/dt	50 V/μs						At ambient temperature of 80°C	

• 3 A type

Item \ Part No.		AQ3A1-C1-ZT5VDC AQ3A1-C2-ZT5VDC	AQ3A1-C1-ZT12VDC AQ3A1-C2-ZT12VDC	AQ3A1-C1-ZT24VDC AQ3A1-C2-ZT24VDC	AQ3A2-C1-ZT5VDC AQ3A2-C2-ZT5VDC	AQ3A2-C1-ZT12VDC AQ3A2-C2-ZT12VDC	AQ3A2-C1-ZT24VDC AQ3A2-C2-ZT24VDC	Remarks
Input side	Control voltage	5 V DC (4 to 6V)	12 V DC (9.6 to 14.4V)	24 V DC (21.6 to 26.4V)	5 V DC (4 to 6V)	12 V DC (9.6 to 14.4V)	24 V DC (21.6 to 26.4V)	The parenthesized values represent the allowable voltage ranges
	Input impedance	Approx. 0.18 k Ω	Approx. 0.55 k Ω	Approx. 1.4 k Ω	Approx. 0.18 k Ω	Approx. 0.55 k Ω	Approx. 1.4 k Ω	
	Drop-out voltage	min. 0.5 V	min. 1.2 V	min. 2.4 V	min. 0.5 V	min. 1.2 V	min. 2.4 V	
Load side	Max. load current	3 A*1						At ambient temperature of 30°C or less
	Load voltage	75 to 125 V AC			75 to 250 V AC			
	Frequency	45 to 65 Hz						
	Repetitive peak OFF voltage	400 V			600 V			
	Non-repetitive surge current	80 A*2						In one cycle at 60 Hz
	Max. "OFF-state" leakage current	2.5 mA/100 V applied			5 mA/200 V applied			
	Max. "ON-state" voltage drop	1.6 V						at max. carrying current
	Min. load current	25 mA*3			50 mA*3			
OFF state dV/dt	50 V/μs						At ambient temperature of 80°C	

Notes: *1) Refer REFERENCE DATA 1, characteristics of load current vs. ambient temperature.

*2) Refer to REFERENCE DATA 2, characteristics of non-repetitive surge current vs. carrying time.

*3) When the load current is less than the min. load current, refer to "NOTES (Page 6)".

2) Non zero-cross type

• 2 A type

Item		Part No.	AQ2A1-C1-T5VDC AQ2A1-C2-T5VDC	AQ2A1-C1-T12VDC AQ2A1-C2-T12VDC	AQ2A1-C1-T24VDC AQ2A1-C2-T24VDC	AQ2A2-C1-T5VDC AQ2A2-C2-T5VDC	AQ2A2-C1-T12VDC AQ2A2-C2-T12VDC	AQ2A2-C1-T24VDC AQ2A2-C2-T24VDC	Remarks
Input side	Control voltage	5 V DC (4 to 6V)	12 V DC (9.6 to 14.4V)	24 V DC (21.6 to 26.4V)	5 V DC (4 to 6V)	12 V DC (9.6 to 14.4V)	24 V DC (21.6 to 26.4V)	The parenthesized values represent the allowable voltage ranges	
	Input impedance	Approx. 0.3 k Ω	Approx. 0.8 k Ω	Approx. 1.8 k Ω	Approx. 0.3 k Ω	Approx. 0.8 k Ω	Approx. 1.8 k Ω		
	Drop-out voltage	min. 0.5 V	min. 1.2 V	min. 2.4 V	min. 0.5 V	min. 1.2 V	min. 2.4 V		
Load side	Max. load current	2 A*1						At ambient temperature of 30°C or less	
	Load voltage	75 to 125 V AC			75 to 250 V AC				
	Frequency	45 to 65 Hz							
	Repetitive peak OFF voltage	400 V			600 V				
	Non-repetitive surge current	30 A*2						In one cycle at 60 Hz	
	Max. "OFF-state" leakage current	2.5 mA/100 V applied			5 mA/200 V applied				
	Max. "ON-state" voltage drop	1.6 V						at max. carrying current	
	Min. load current	25 mA*3			50 mA*3				
	OFF state dV/dt	50 V/ μ s						At ambient temperature of 80°C	

• 3 A type

Item		Part No.	AQ3A1-C1-T5VDC AQ3A1-C2-T5VDC	AQ3A1-C1-T12VDC AQ3A1-C2-T12VDC	AQ3A1-C1-T24VDC AQ3A1-C2-T24VDC	AQ3A2-C1-T5VDC AQ3A2-C2-T5VDC	AQ3A2-C1-T12VDC AQ3A2-C2-T12VDC	AQ3A2-C1-T24VDC AQ3A2-C2-T24VDC	Remarks
Input side	Control voltage	5 V DC (4 to 6V)	12 V DC (9.6 to 14.4V)	24 V DC (21.6 to 26.4V)	5 V DC (4 to 6V)	12 V DC (9.6 to 14.4V)	24 V DC (21.6 to 26.4V)	The parenthesized values represent the allowable voltage ranges	
	Input impedance	Approx. 0.3 k Ω	Approx. 0.8 k Ω	Approx. 1.8 k Ω	Approx. 0.3 k Ω	Approx. 0.8 k Ω	Approx. 1.8 k Ω		
	Drop-out voltage	min. 0.5 V	min. 1.2 V	min. 2.4 V	min. 0.5 V	min. 1.2 V	min. 2.4 V		
Load side	Max. load current	3 A*1						At ambient temperature of 30°C or less	
	Load voltage	75 to 125 V AC			75 to 250 V AC				
	Frequency	45 to 65 Hz							
	Repetitive peak OFF voltage	400 V			600 V				
	Non-repetitive surge current	80 A*2						In one cycle at 60 Hz	
	Max. "OFF-state" leakage current	2.5 mA/100 V applied			5 mA/200 V applied				
	Max. "ON-state" voltage drop	1.6 V						at max. carrying current	
	Min. load current	25 mA*3			50 mA*3				
	OFF state dV/dt	50 V/ μ s						At ambient temperature of 80°C	

Notes: *1) Refer REFERENCE DATA 1, characteristics of load current vs. ambient temperature.

*2) Refer to REFERENCE DATA 2, characteristics of non-repetitive surge current vs. carrying time.

*3) When the load current is less than the min. load current, refer to "NOTES (Page 6)".

AQ8

2. Characteristics (Ambient temperature: 20°C 68°F; Input voltage ripple: 1% or less)

Item	Type	Zero-cross type	Non zero-cross type	Remarks
Operate time, max.		1/2 cycle of voltage sine wave + 1 ms	1 ms	
Release time, max.		1/2 cycle of voltage sine wave + 1 ms		
Insulation resistance, min.		10 ⁹ Ω between input and output		at 500 V DC
Breakdown voltage		3,000 V AC between input and output		For 1 minute
Vibration resistance	Functional	10 to 55 Hz at double amplitude of 3 mm		10 min. for X, Y, Z axis
	Destructive	10 to 55 Hz at double amplitude of 3 mm		1 hour for X, Y, Z axis
Shock resistance	Functional	Min. 980 m/s ² {100 G}		4 times each for X, Y, Z axis
	Destructive	Min. 980 m/s ² {100 G}		5 times each for X, Y, Z axis
Ambient temperature		-30°C to +80°C -22°F to +176°F		
Storage temperature		-30°C to +100°C -22°F to +212°F		
Operational method		Zero-cross (Turn ON and Turn OFF)	Non zero-cross turn ON, zero-cross turn OFF	

DIMENSIONS

mm inch

(Common for zero-cross and non zero-cross types)

1. Input terminals distance 5.08 mm .200 inch

1) 2 A type

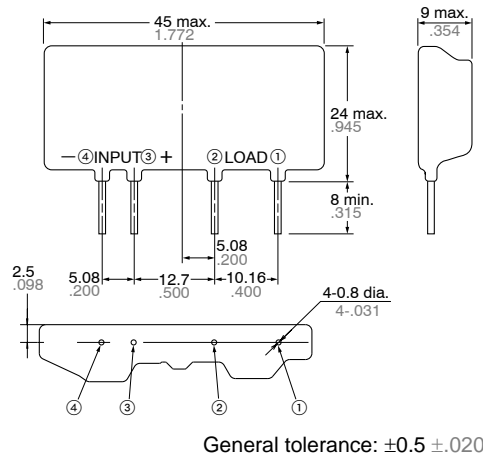
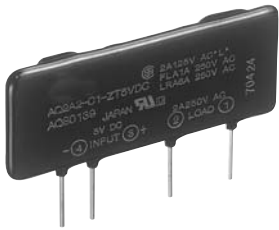

General tolerance: ±0.5 ±.020

Mounting hole location (Bottom view)

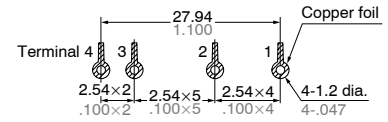

Tolerance: ±0.1 ±.004

Schematic

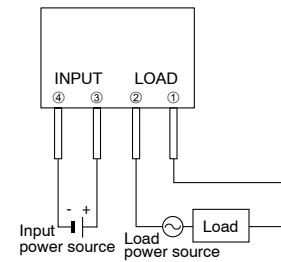

2) 3 A type

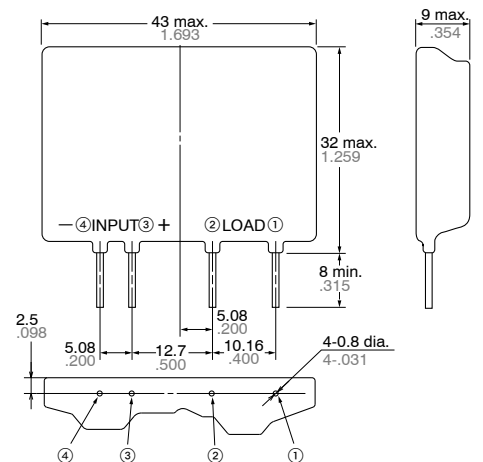

General tolerance: ±0.5 ±.020

Mounting hole location (Bottom view)

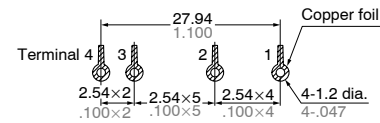

Tolerance: ±0.1 ±.004

Schematic

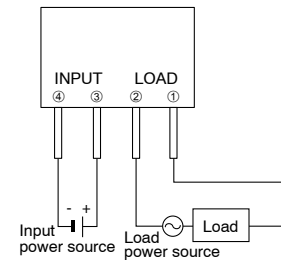

2. Input terminals distance 7.62 mm .300 inch

1) 2A type

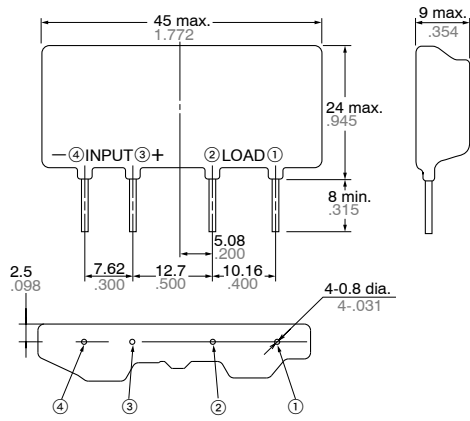
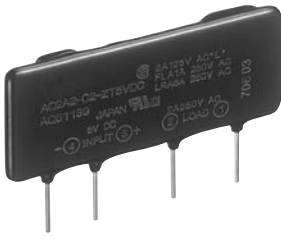

General tolerance: $\pm 0.5 \pm 0.020$

Mounting hole location (Bottom view)

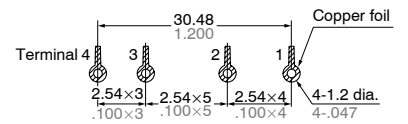

Tolerance: $\pm 0.1 \pm 0.004$

Schematic

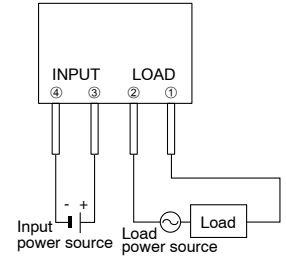

2) 3A type

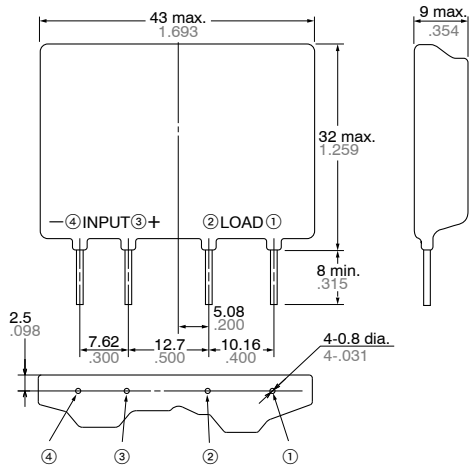

General tolerance: $\pm 0.5 \pm 0.020$

Mounting hole location (Bottom view)

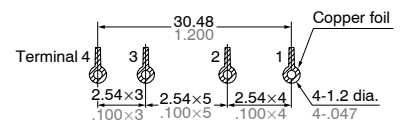

Tolerance: $\pm 0.1 \pm 0.004$

Schematic

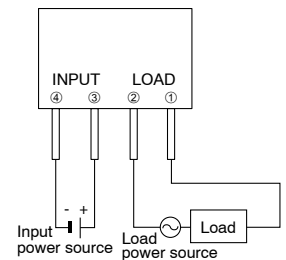

REFERENCE DATA

1. Characteristics of load current vs. ambient temperature

Conditions: Natural cooling

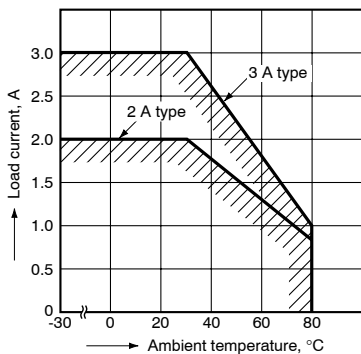

2. Characteristics of non-repetitive surge current vs. carrying time

(2 A type)

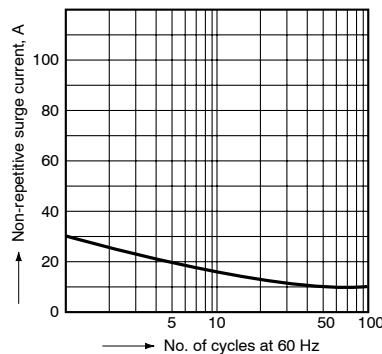

(3 A type)

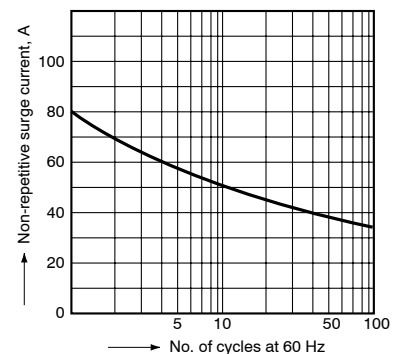

AQ8

3. Characteristics of input current vs. input voltage

—zero-cross type ---non zero-cross type

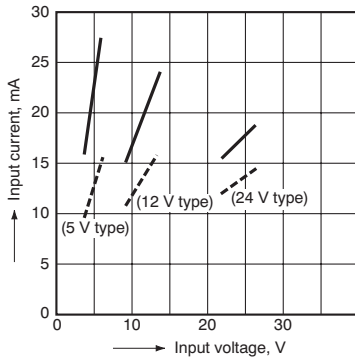

4. Characteristics of load current vs. ambient temperature for adjacent mounting

Conditions: Natural cooling
(2 A type)

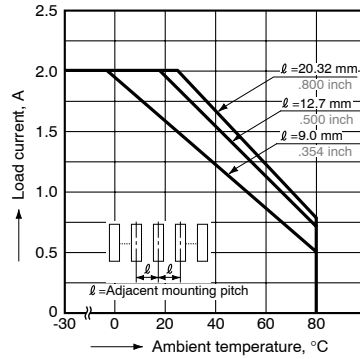

(3 A type)

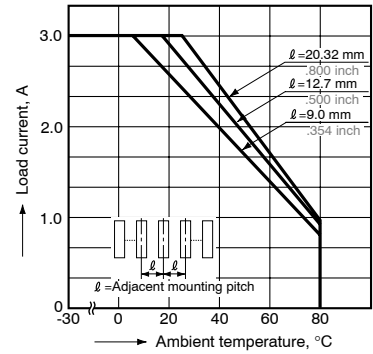

Approved standards list

Product name	File No.	Qualified ratings
AQ8	UL E95895	2A type: 2 A 125, 250 V AC 2 A 125 V AC (Tungsten) FLA 1 A, LRA 6 A 125, 250 V AC
	CSA LR26550	3A type: 3 A 125, 250 V AC 3 A 125 V AC (Tungsten) FLA 1.5 A, LRA 9 A 125, 250 V AC

NOTES

1. When used for the load less than rated

In case of the load current less than rated, malfunction may result from the residual voltage across the both ends of the load even if the solid state relay is turned off. Use a dummy resistor as a countermeasure.

The total of the current through the resistor and the load current must exceed the min. rated load current.

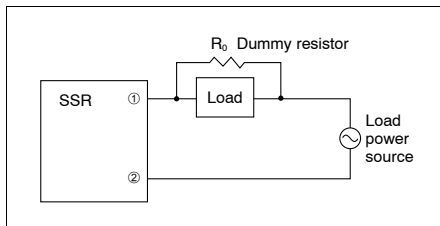

In case the dummy resistor is not used, keep in mind that the residual voltage becomes as follows:

Example:

For the inductive load by the 20 mA load current and the 200 V AC load voltage, the load impedance becomes 10 kΩ and $V_e/V = 14\%$ is estimated from the right above graph. Accordingly, the 28 V voltage remains across the both ends of the load when the solid state relay is turned off.

• Characteristics of residual voltage vs. load impedance

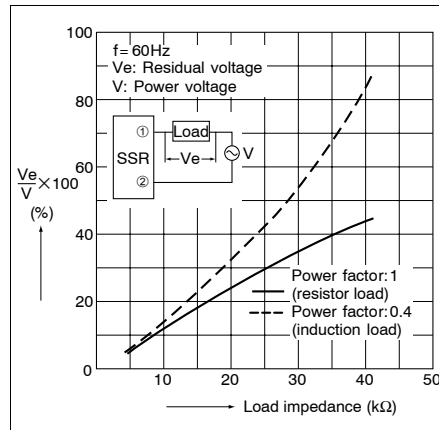

2. Solder the terminals within 5 seconds at 260°C 500°F.

3. When the terminal is bent

Care shall be taken neither to apply mechanical stresses to the mold area of the solid state relay nor to bend the terminal 45 degrees or more.

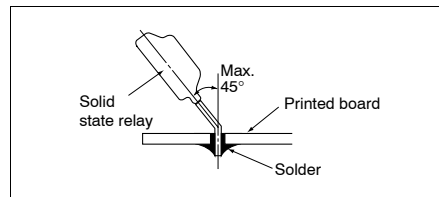

Cautions for Use